

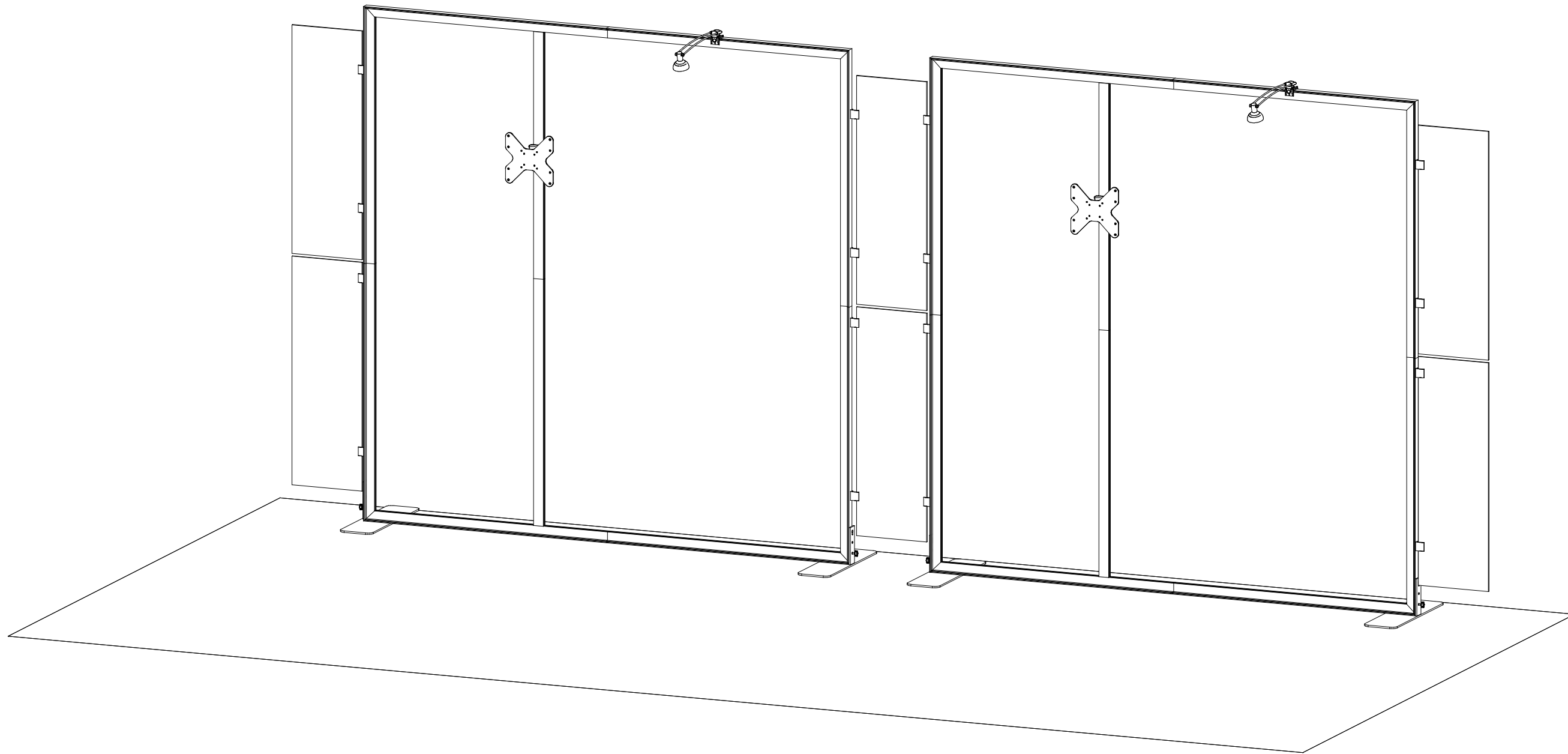

Plan View

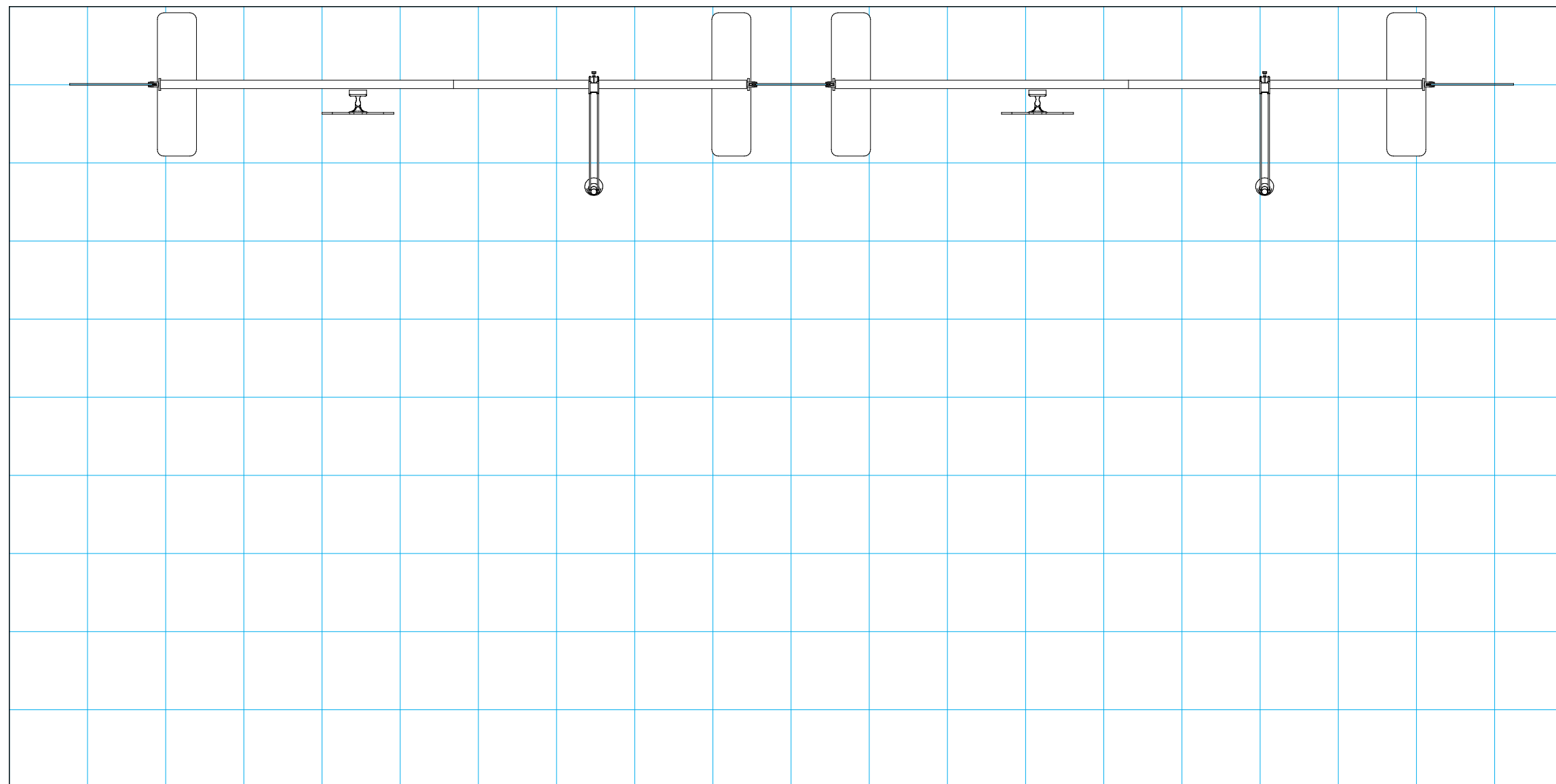

SETUP INSTRUCTIONS



 = 1 sq foot

General Setup Instructions

- Read entire setup instruction manual prior to unpacking parts and pieces.
- The setup instructions are created specifically for this configuration.
- Setup instructions are laid out sequentially in steps, including exploded views with detailed explanation for assembly.



Part Identification - Numbering

Cleaning & Packing

- For Cleaning Metal, Plex, & Laminate Parts: Use a **MILD NON-ABRASIVE** cleanser and soft cloth/paper towel to clean all surfaces.
- Keep exhibit components away from heat and prolonged sun exposure.
Heat and UV exposure will warp and fade components.
- Retain all provided Packing Materials. All provided packing materials are for ease of repacking & component protection.



Engaged Lock



WARNING



DO NOT USE POWER TOOLS



ALL CONNECTIONS MUST
BE TIGHTLY SECURED

Disassembly

- For loss prevention, keep all knobs & connectors attached to extrusions during disassembly.

Straight Connection

When assembling frame, first attach all **straight connectors**, then attach **corner connectors**.

- 1) Place extrusions end-to-end.
- 2) Loosen all knobs, then slide **straight connector** across the seam of extrusions.
- 3) Tighten all knobs to secure connection.

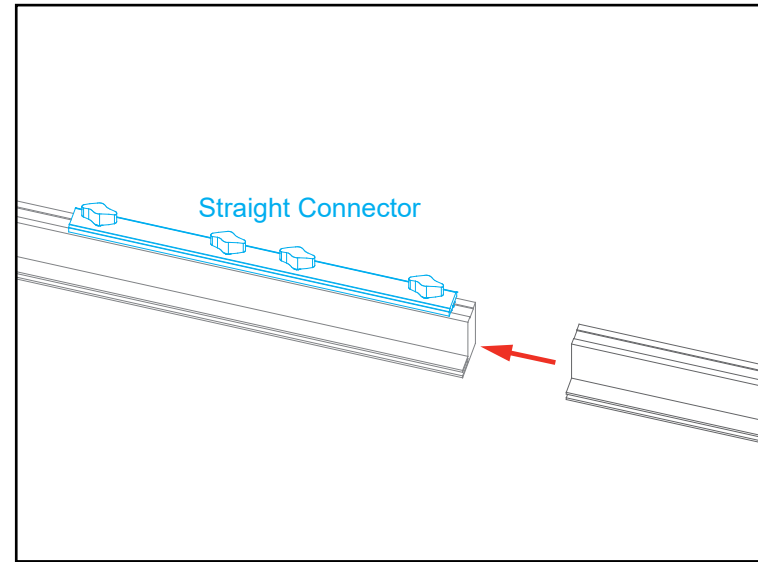

Slide connector across seam of extrusions.
Tighten all knobs.

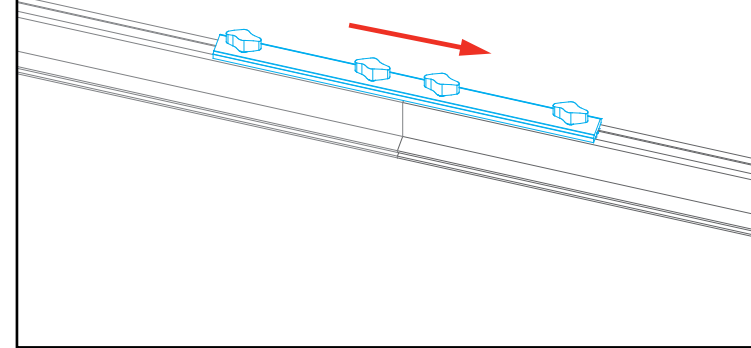

All knobs must be tightened securely to ensure a proper connection.

Disassembly

- 1) Loosen all knobs.
- 2) Slide connectors off of one extrusion.
- 3) Tighten knobs to prevent loss during packing & shipping.

Keep straight connectors in groove of extrusion. Do not remove connectors during disassembly.

Corner Connection

- 1) Loosen knobs, then slide vertical extrusions onto **corner connectors** of **lower** horizontal extrusion.
- 2) Slide **corner connectors** of **upper** horizontal extrusion into grooves of vertical extrusions.
- 3) Tighten all knobs to secure connection.

Disassembly

- 1) Loosen knobs on vertical extrusions.
- 2) Slide the vertical extrusions off of **corner connectors** on lower and upper horizontal extrusions.

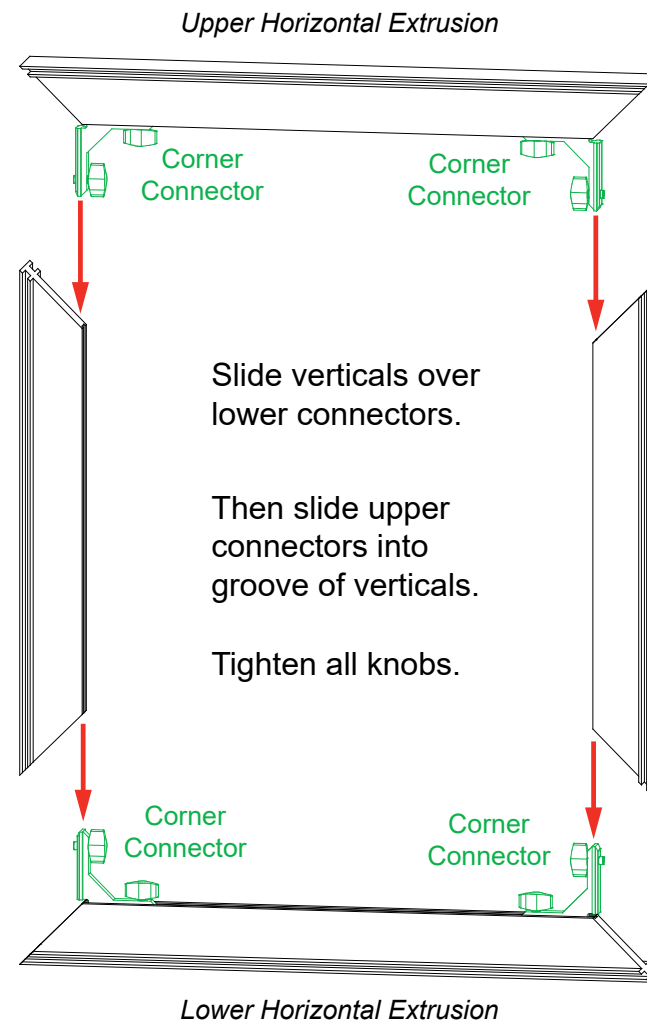

Slide verticals over lower connectors.

Then slide upper connectors into groove of verticals.

Tighten all knobs.



Adjust connectors if necessary to prevent gaps in connection.

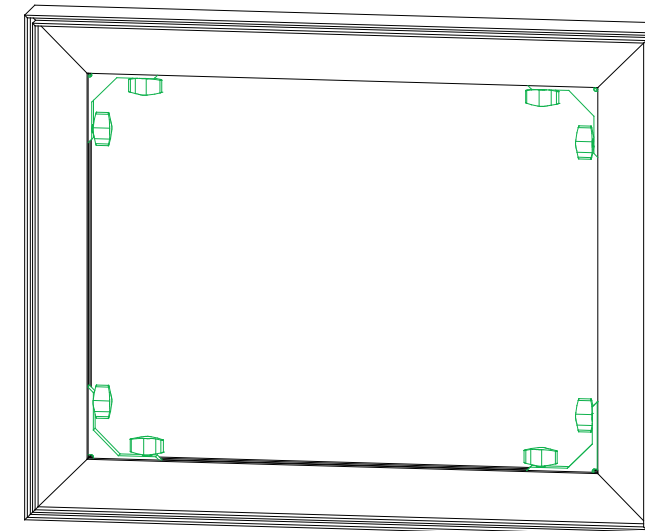

COMPLETED ASSEMBLY

All knobs must be tightened securely to ensure a proper connection.

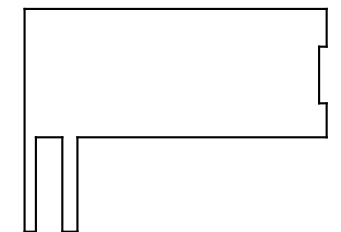

TSP46 Profile

SEG Graphic Installation *in 3 Steps*

The Perfect Fit

STEP 1: Attach Corners

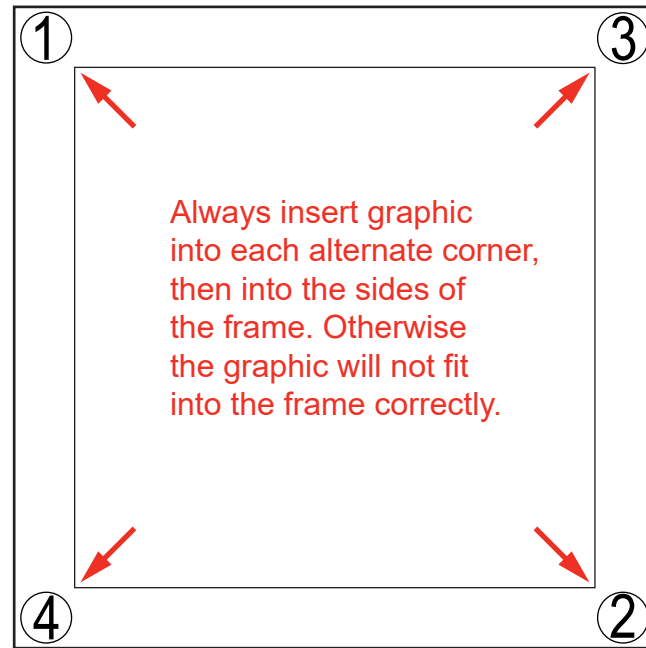

STEP 2: Attach Middle

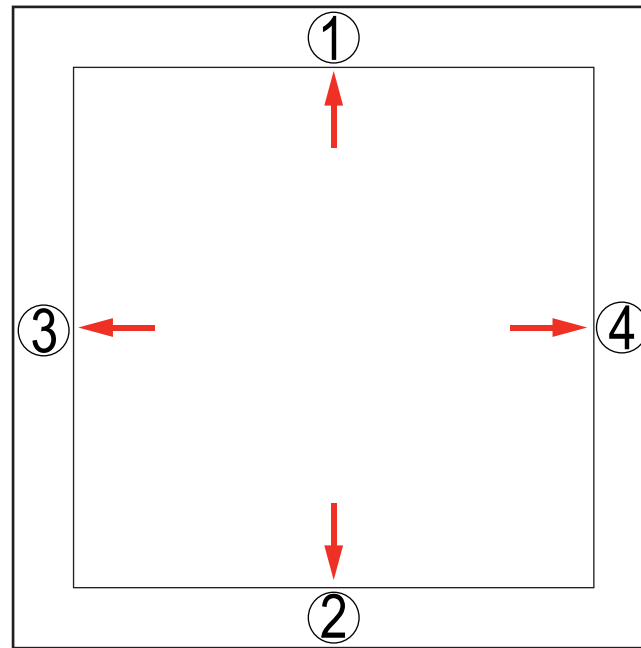

STEP 3: Attach Sides

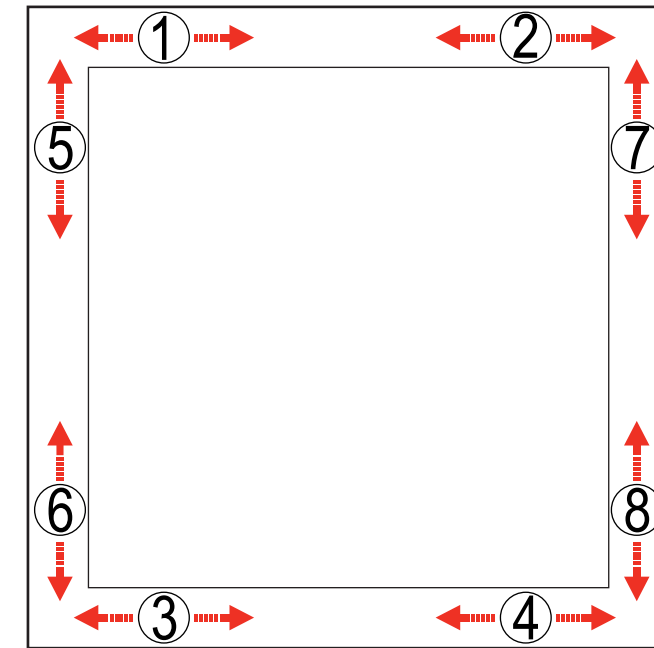

Insert narrow side of silicone welt into the channel at corner 1, with fabric to the outside.

Repeat for opposite corner 2, then corner 3, then corner 4.

Once corners are attached, press the middle of edge 1 into the channel. Then press middle of edge 2 into the channel on opposite side.

Repeat with edge 3 & 4.

Once the middle of sides are attached, fully press the silicone welt into the channel, between center and corner at location 1. Repeat the process between center and corner at location 2.

Do the same for welt on opposite side, at locations 3 & 4. Then repeat for locations 5 & 6 and 7 & 8.

Once the welt is fully inserted on all sides, smooth out edges as needed for a perfect fit.



To remove the graphic from the frame, locate the fabric **pull tab**. Gently pull on the tab to remove the graphic.

Install video:



Top View of Each Level

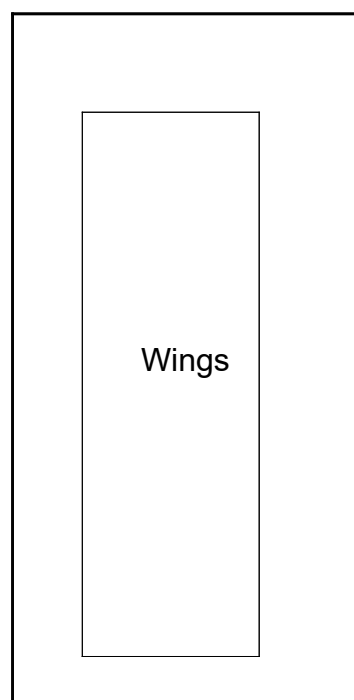

Level 1
(Bottom level)

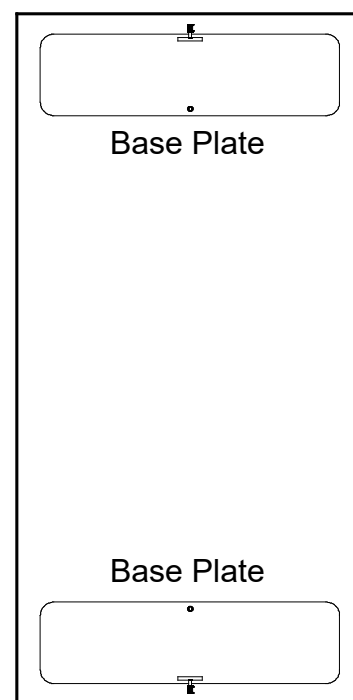

Level 2

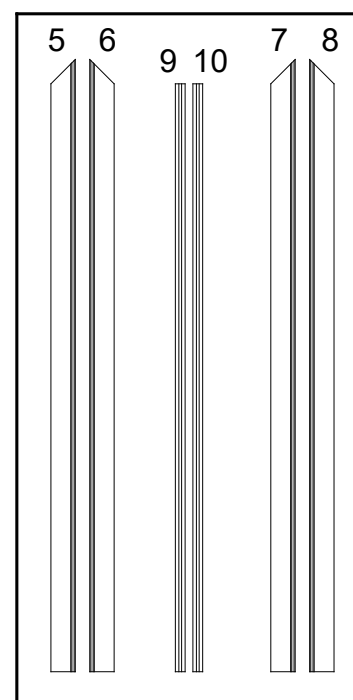

Level 3

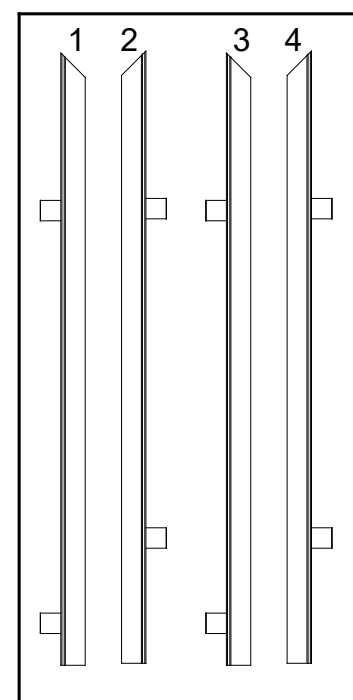

Level 4

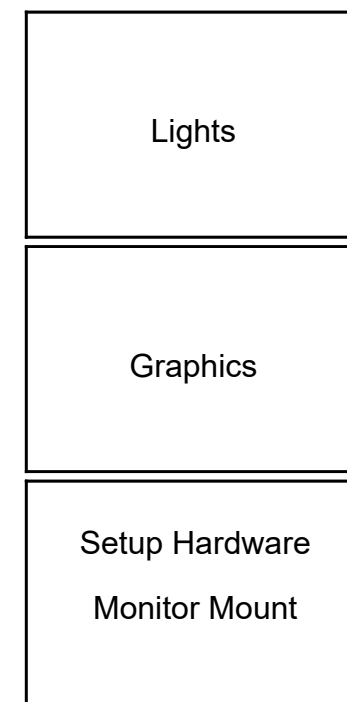

Top View of Each Level

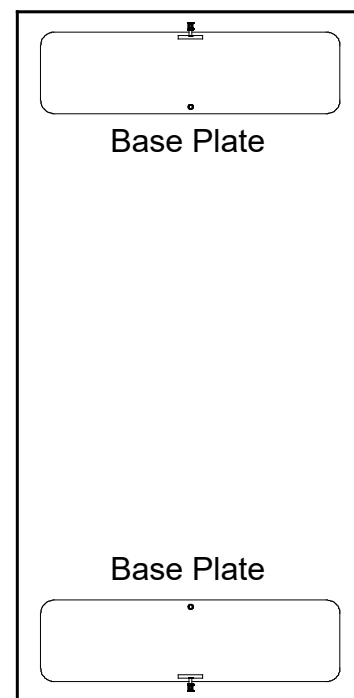

Level 1
(Bottom level)

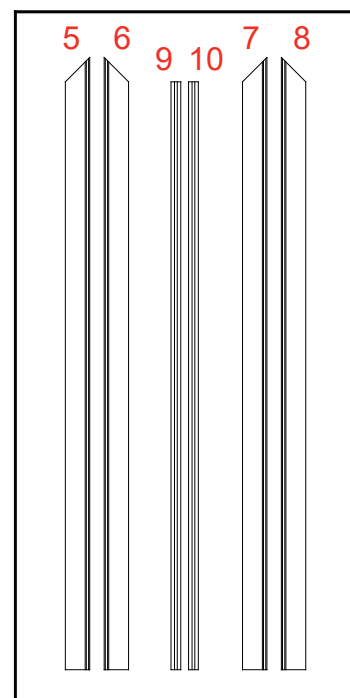

Level 2

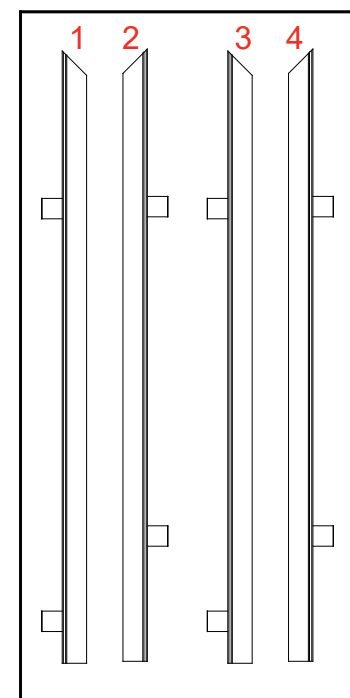

Level 3

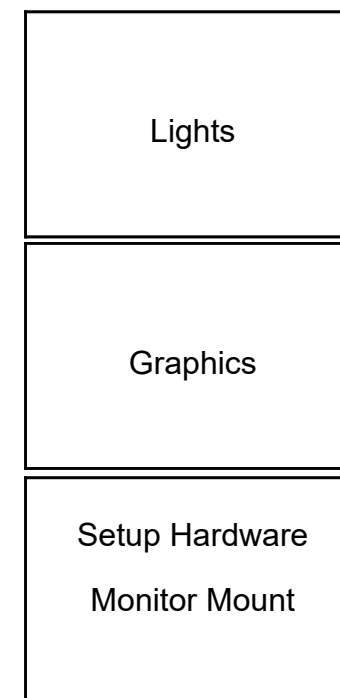

Item	Qty.	Description
1,1	1,1	45"h TSP46 Vertical Extrusion
2,2	1,1	45"h TSP46 Vertical Extrusion
3,3	1,1	45"h TSP46 Vertical Extrusion
4,4	1,1	45"h TSP46 Vertical Extrusion
5,5	1,1	45"w TSP46 Horizontal Extrusion
6,6	1,1	45"w TSP46 Horizontal Extrusion
7,7	1,1	45"w TSP46 Horizontal Extrusion
8,8	1,1	45"w TSP46 Horizontal Extrusion
9,9	1,1	43.209"h Z45 Vertical Extrusion
10,10	1,1	43.209"h Z45 Vertical Extrusion
--	4	Base Plate w/ Flange

Steps:

Refer to the *Tool-less Frame Assembly* general information page.

- 1) Assemble extrusions [1-2], [3-4], [5-6], [7-8] & [1-2], [3-4], [5-6], [7-8] together using straight connectors.
- 2) Connect vertical assemblies [1/2], [3/4] between horizontal assemblies [5/6], [7/8] using corner connectors. Repeat step, attaching [1/2], [3/4] between [5/6], [7/8].
- 3) Install Base Plates to bottom corners of frames. See *Base Plate Attachment* detail.
- 4) Lift up frame; attach verticals [9/10] & [9/10] between horizontals using *Connection Lock w/ Knob*.
- 4) Apply SEG graphics to front of frames. See the *SEG Installation* general information page.

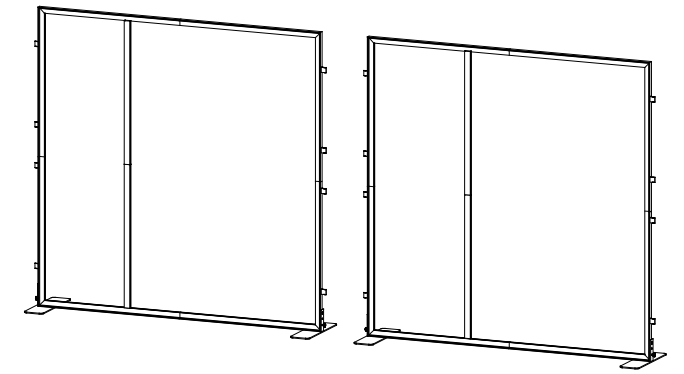

When assembled



Assemble frames flat on ground.

*** Base Plate Attachment**

- 1) Place key hole over bolt on panel & slide down.
- 2) Twist knob to secure connection.

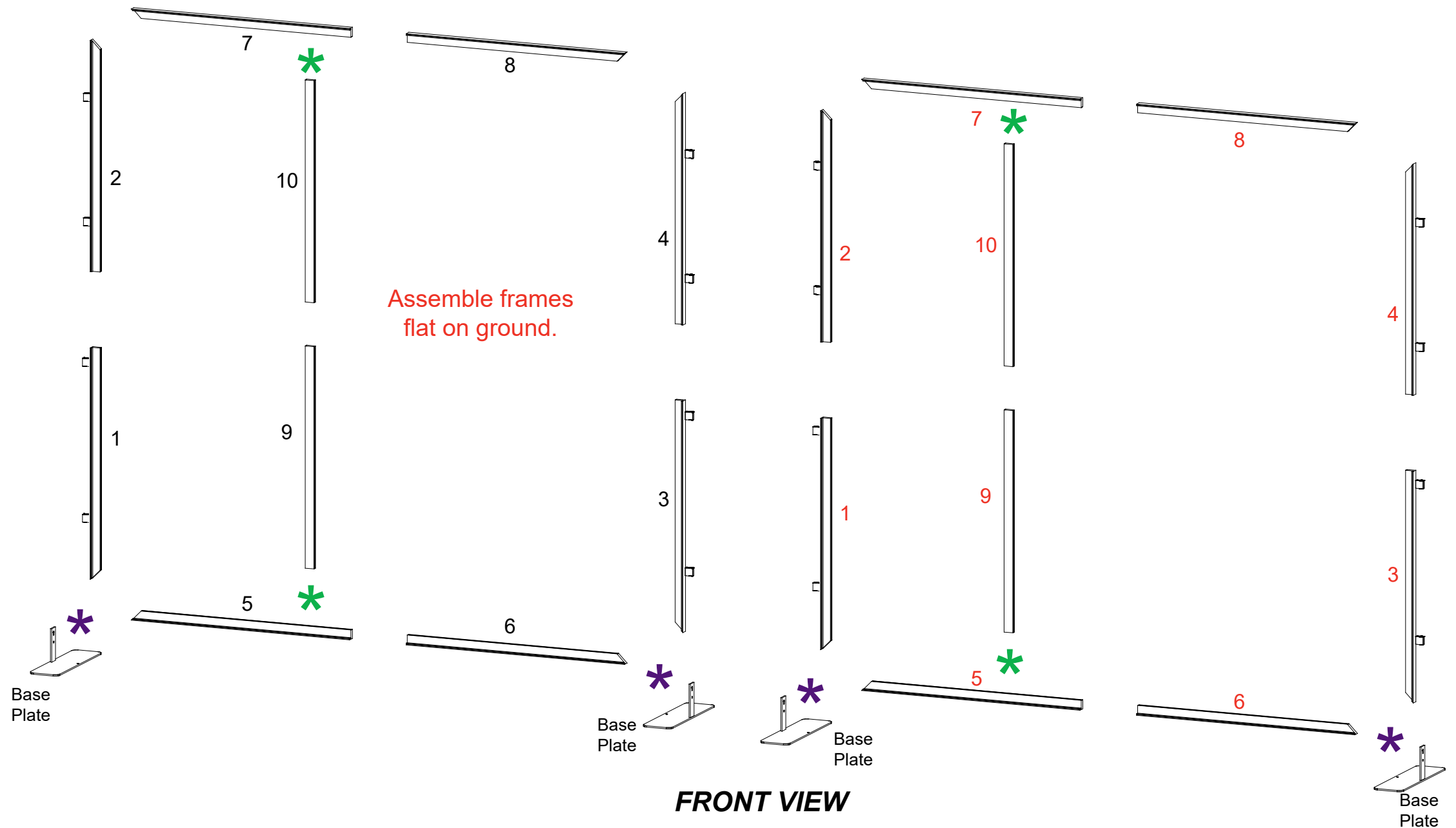
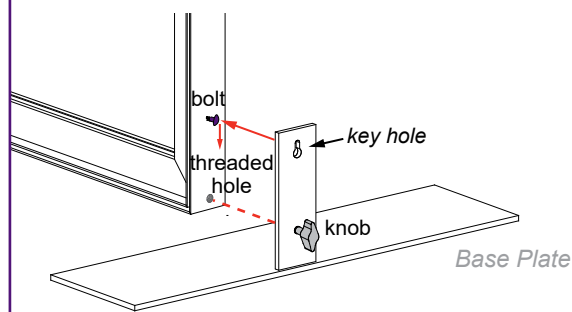

* Monitor Mount Attachment

Attach Monitor Mount back piece to vertical extrusion using bolts. Then slide monitor mount into back piece as shown.

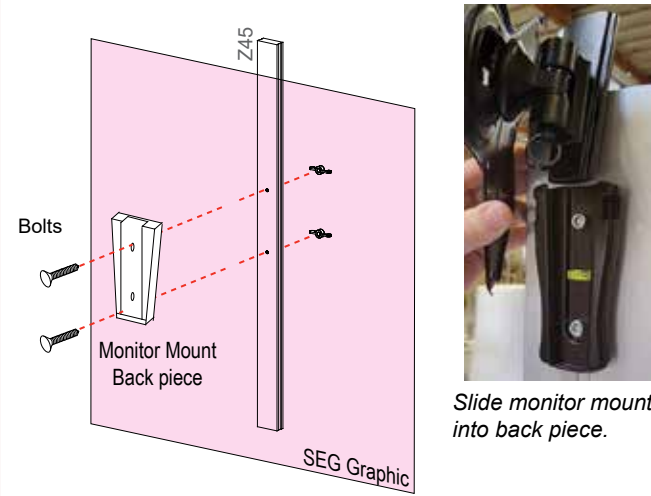

Note: Monitor mounts install through SEG graphic.

A10 Clamp Attachment

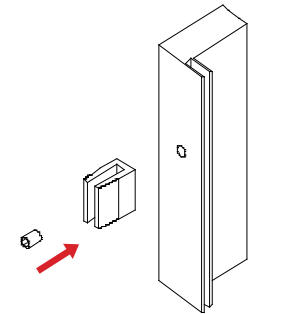

Screw A10 clamp to Vertical Extrusion.

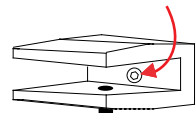

Tighten knob to secure Wing in place.

Clamps should NOT be removed. Leave attached when exhibit is packed.

Steps:

- 1) Connect Wings to A10 clamps on vertical extrusions. See [A10 Clamp Attachment](#) detail.
- 2) Attach light to top of frame. See [Light Attachment](#) detail.
- 3) Connect Monitor Mount to vertical assemblies [9/10] & [9/10]. See [Monitor Mount Attachment](#) detail.

* Light Attachment

Attach clamp of stem light to top of horizontal extrusion where desired.

Twist knob on back to tighten in place.

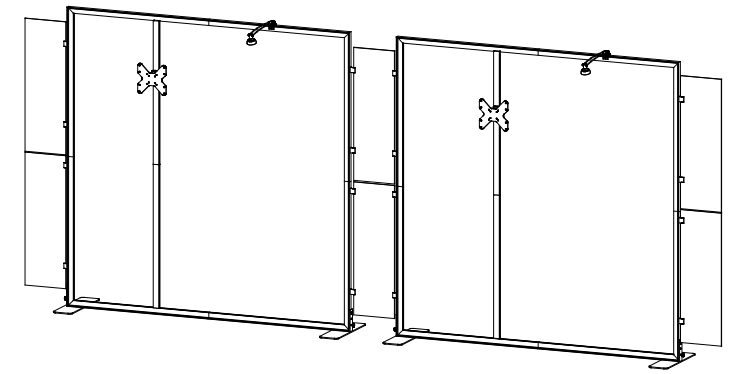
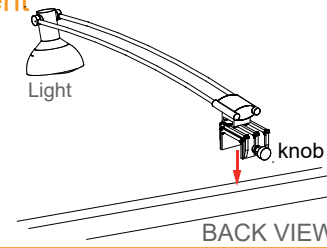

Completed Assembly

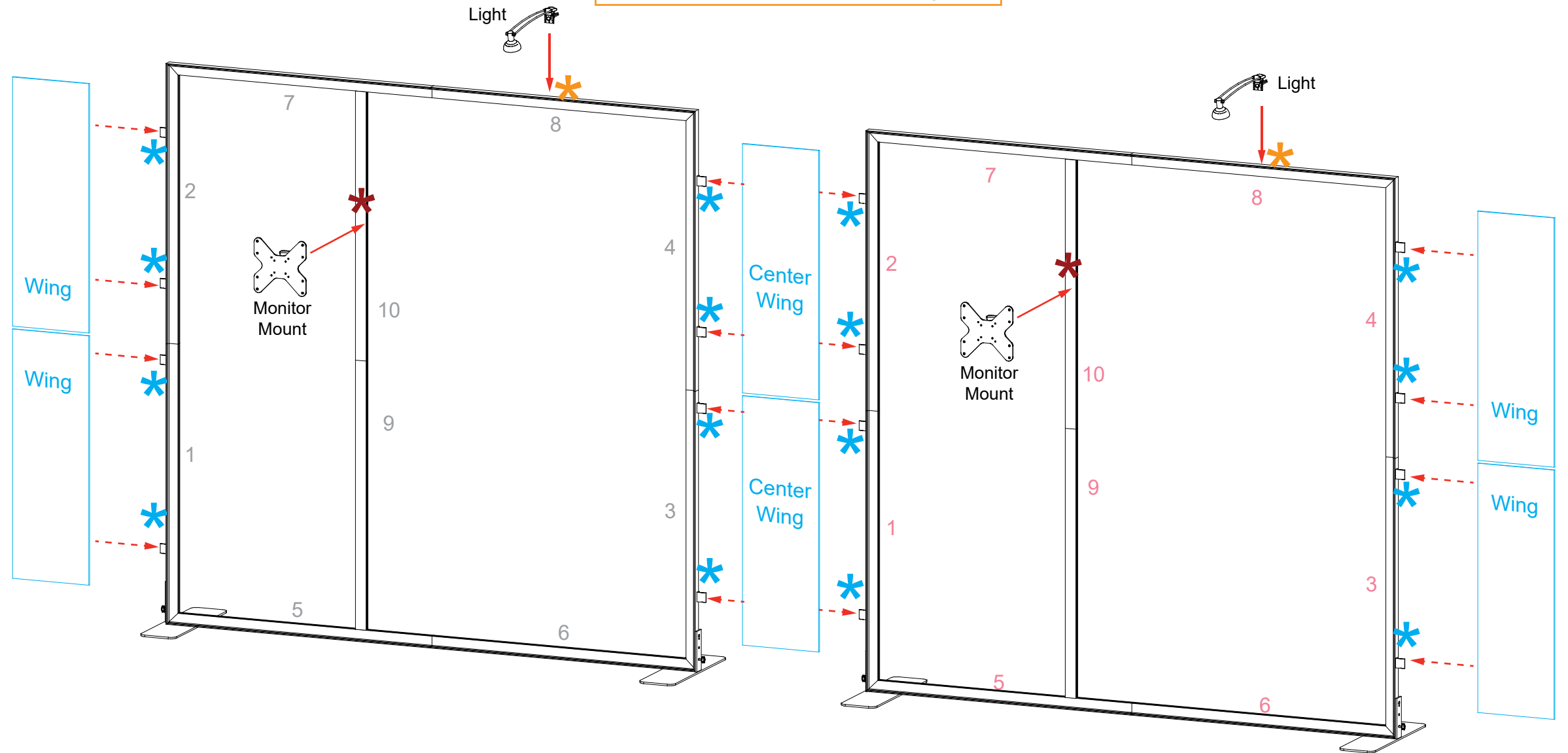

FRONT VIEW